

**HINWEISE ZUR BENUTZUNG DES  
VORLAGEBOGENS:**

- = Schnittlinie
- ..... = darunterliegende Schnittlinie
- - - - - = Faltlinie

S. 6

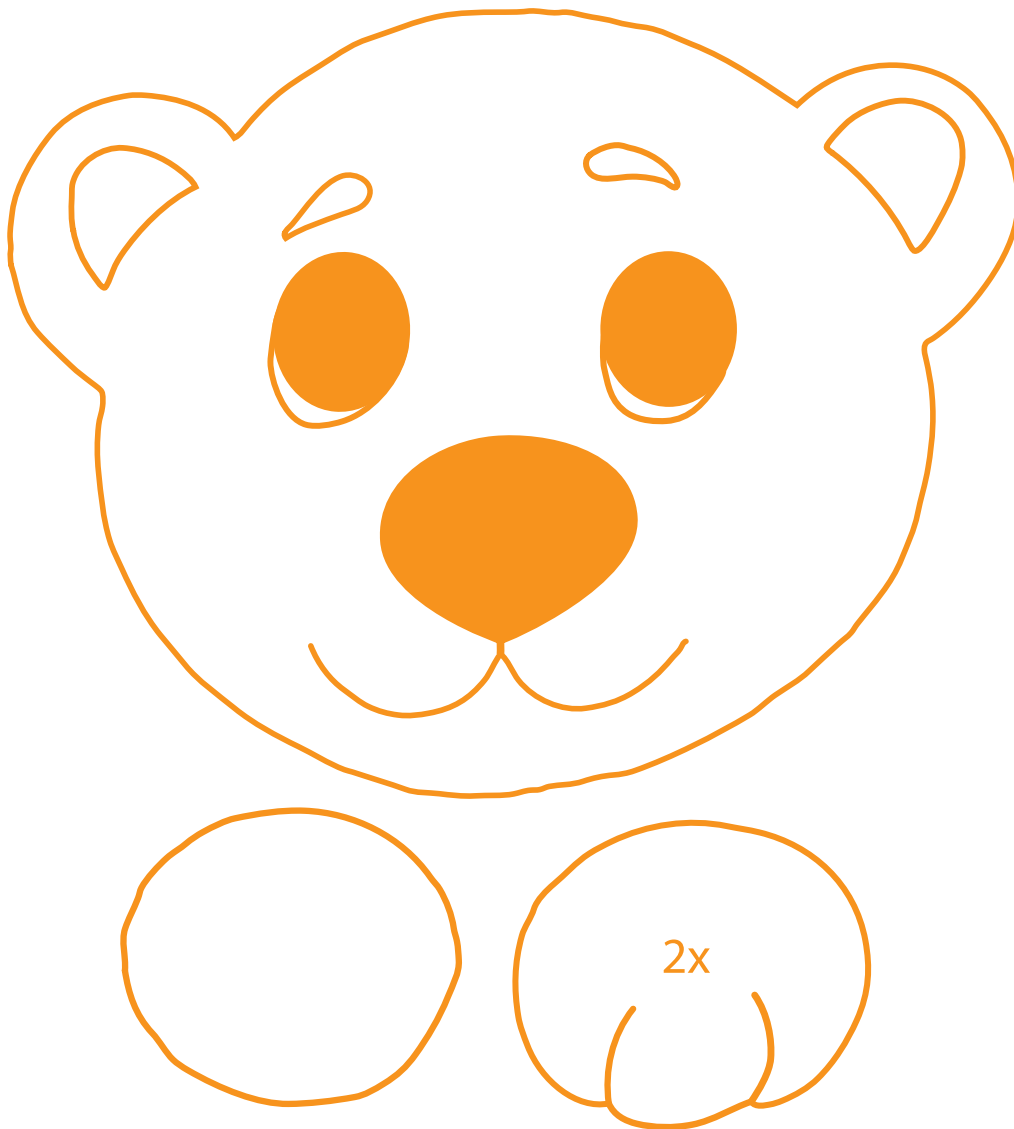

**HINWEISE ZUR BENUTZUNG DES VORLAGEBOGENS:**

- = Schnittlinie
- ..... = darunterliegende Schnittlinie
- = Faltlinie

S. 10

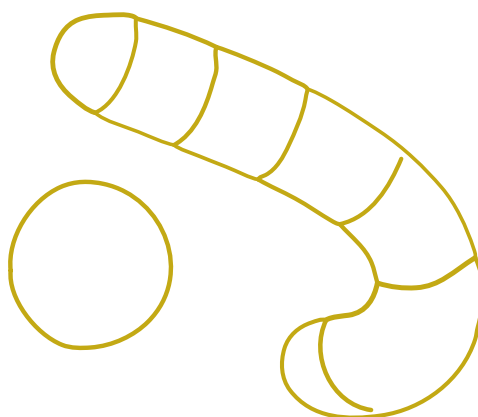
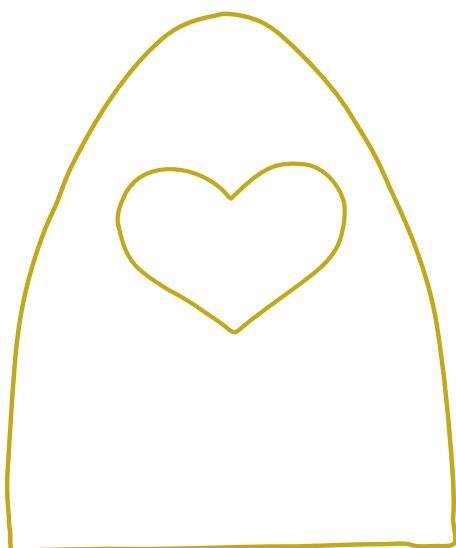
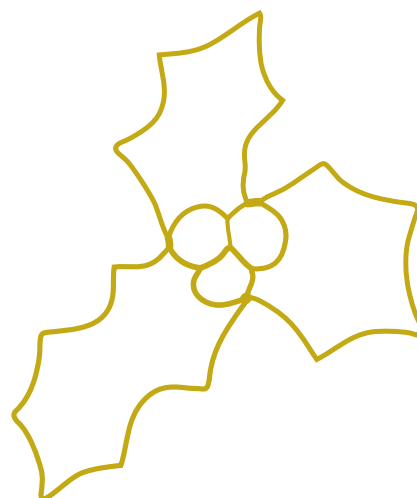
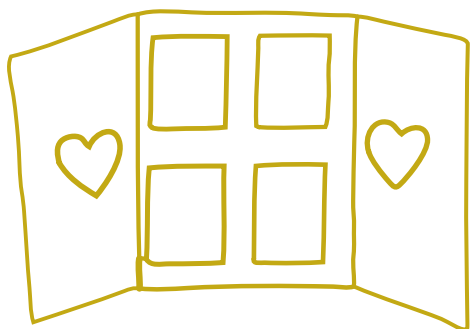

**HINWEISE ZUR BENUTZUNG DES VORLAGEBOGENS:**

- = Schnittlinie
- ..... = darunterliegende Schnittlinie
- - - - - = Faltlinie

S. 15



S. 14

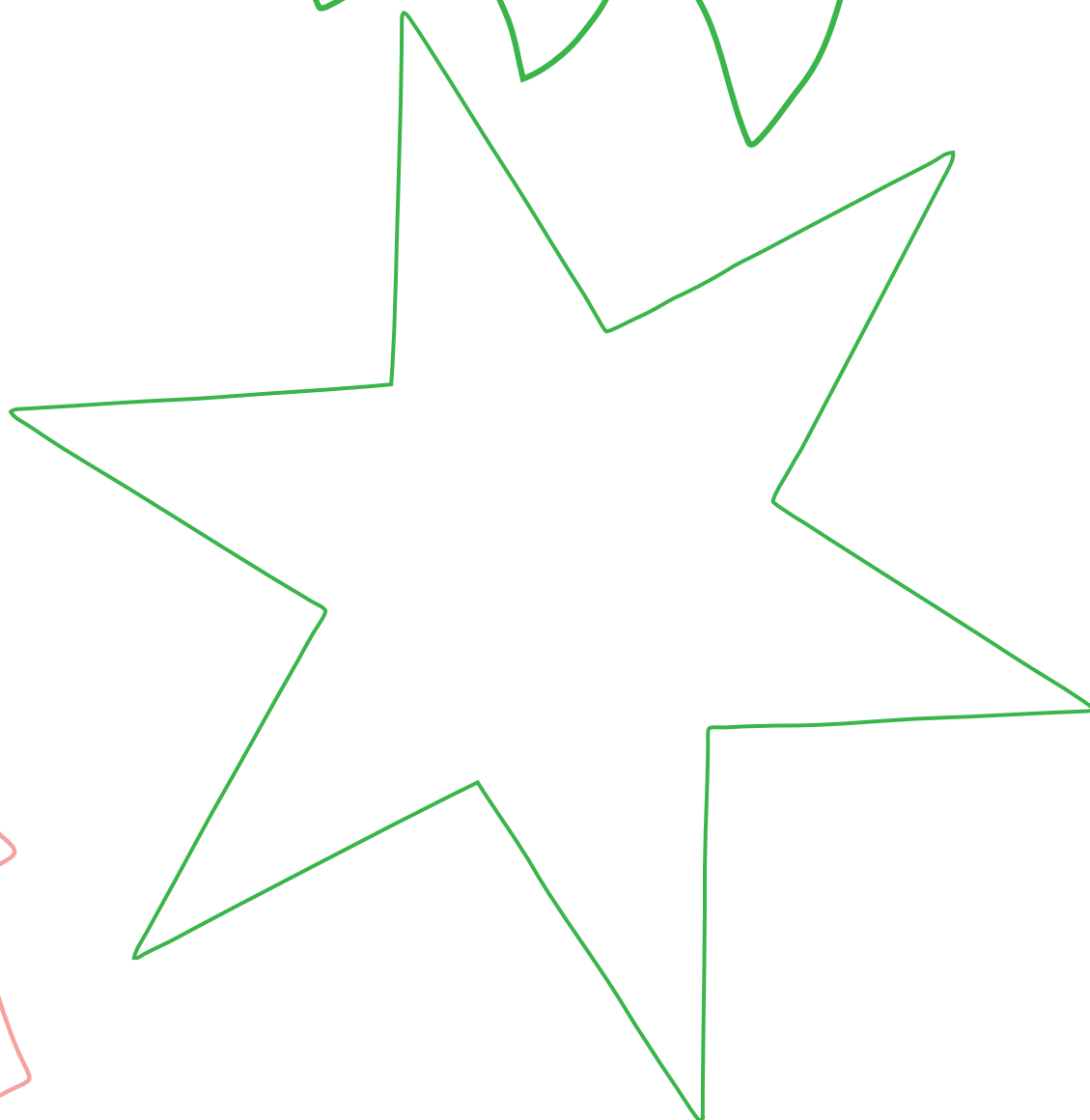
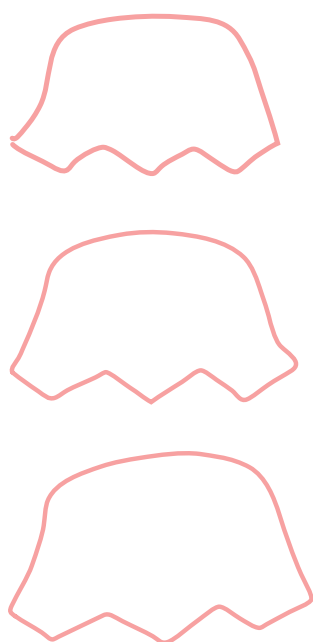

**HINWEISE ZUR BENUTZUNG DES  
VORLAGEBOGENS:**

- = Schnittlinie
- ..... = darunterliegende Schnittlinie
- - - - - = Faltlinie

S. 16

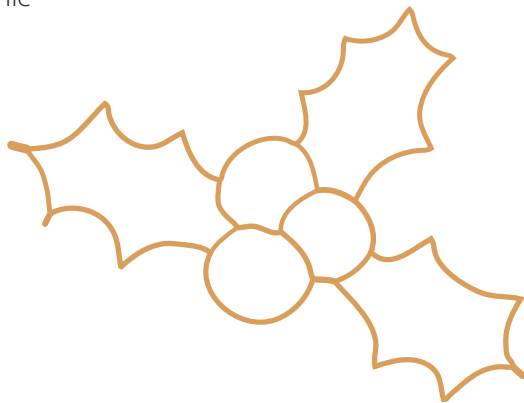

S. 18

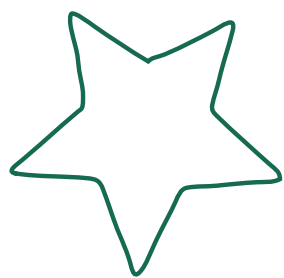
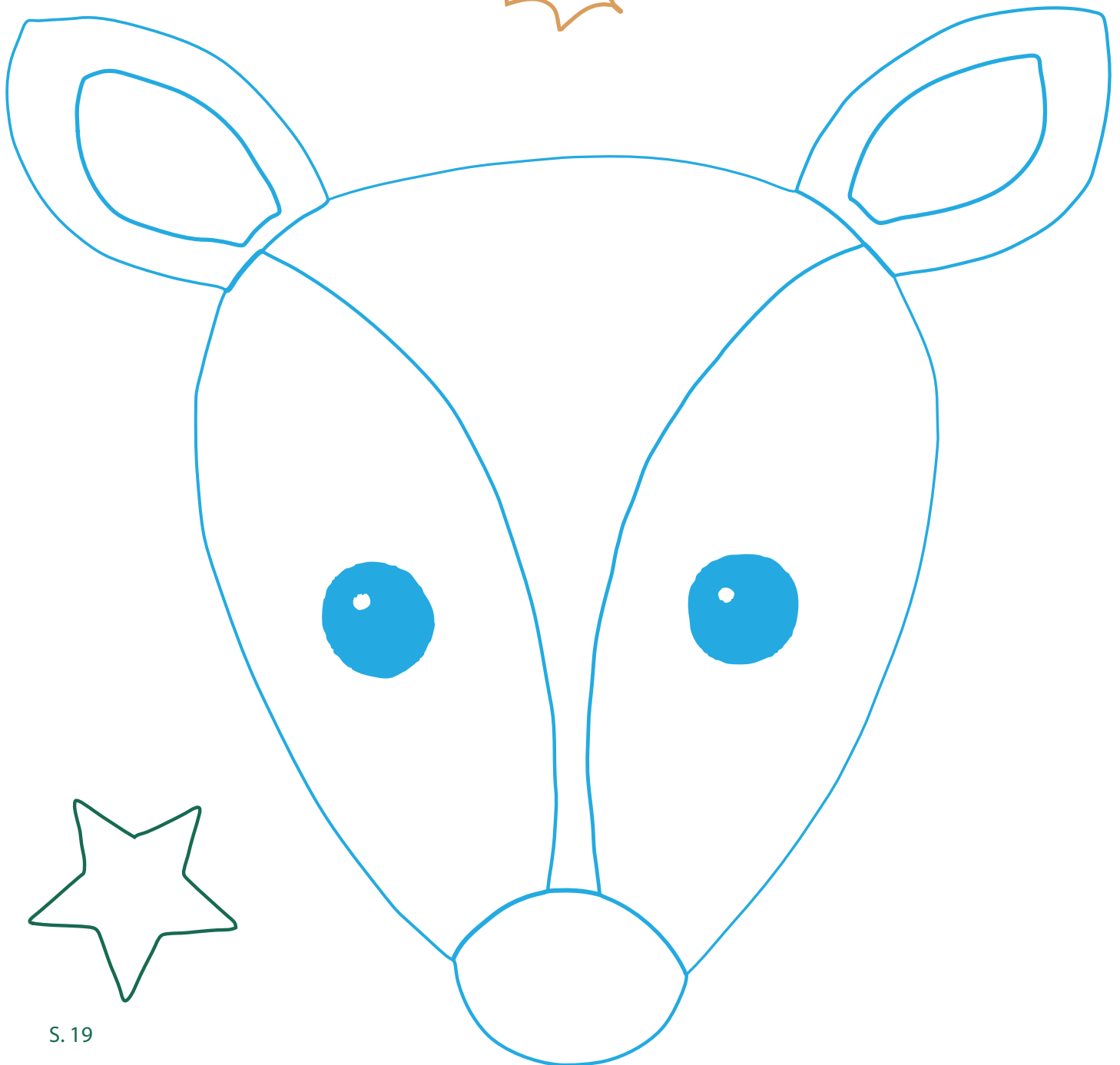

S. 19

**HINWEISE ZUR BENUTZUNG DES  
VORLAGEBOGENS:**

- = Schnittlinie
- ..... = darunterliegende Schnittlinie
- - - - - = Faltlinie

S. 27

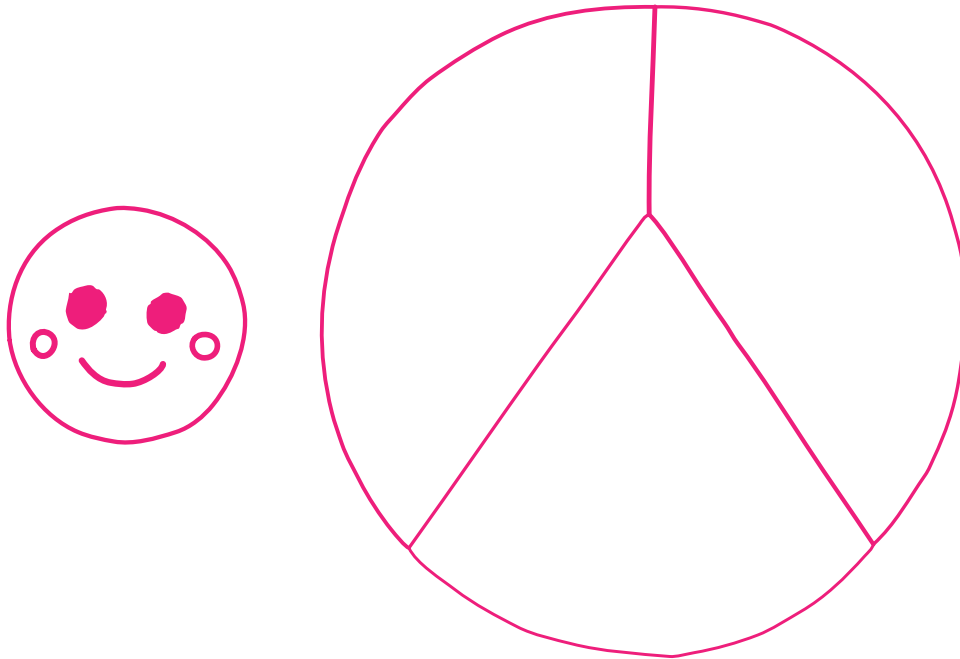

S. 30

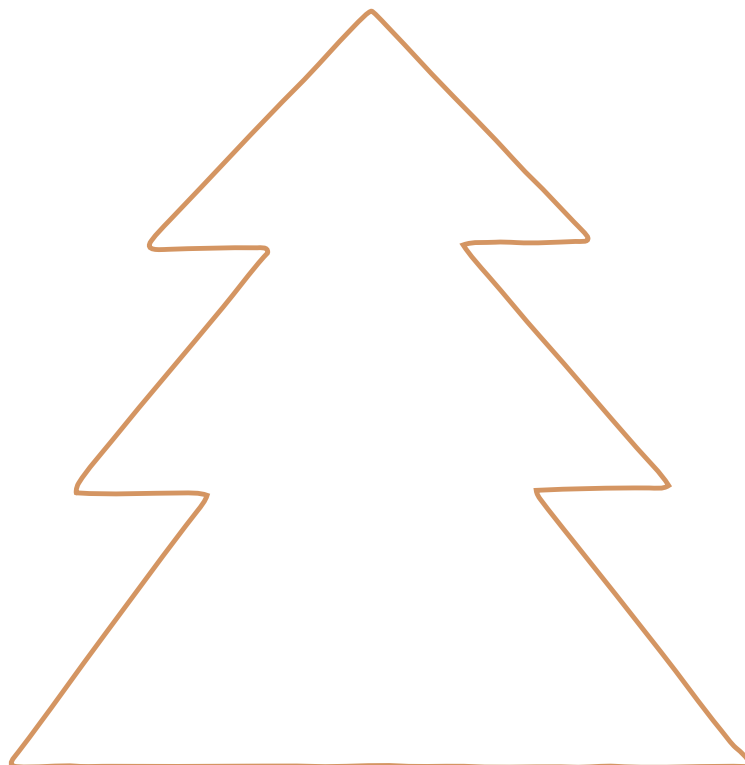

**HINWEISE ZUR BENUTZUNG DES  
VORLAGEBOGENS:**

- = Schnittlinie
- ..... = darunterliegende Schnittlinie
- - - - - = Faltlinie

S. 28

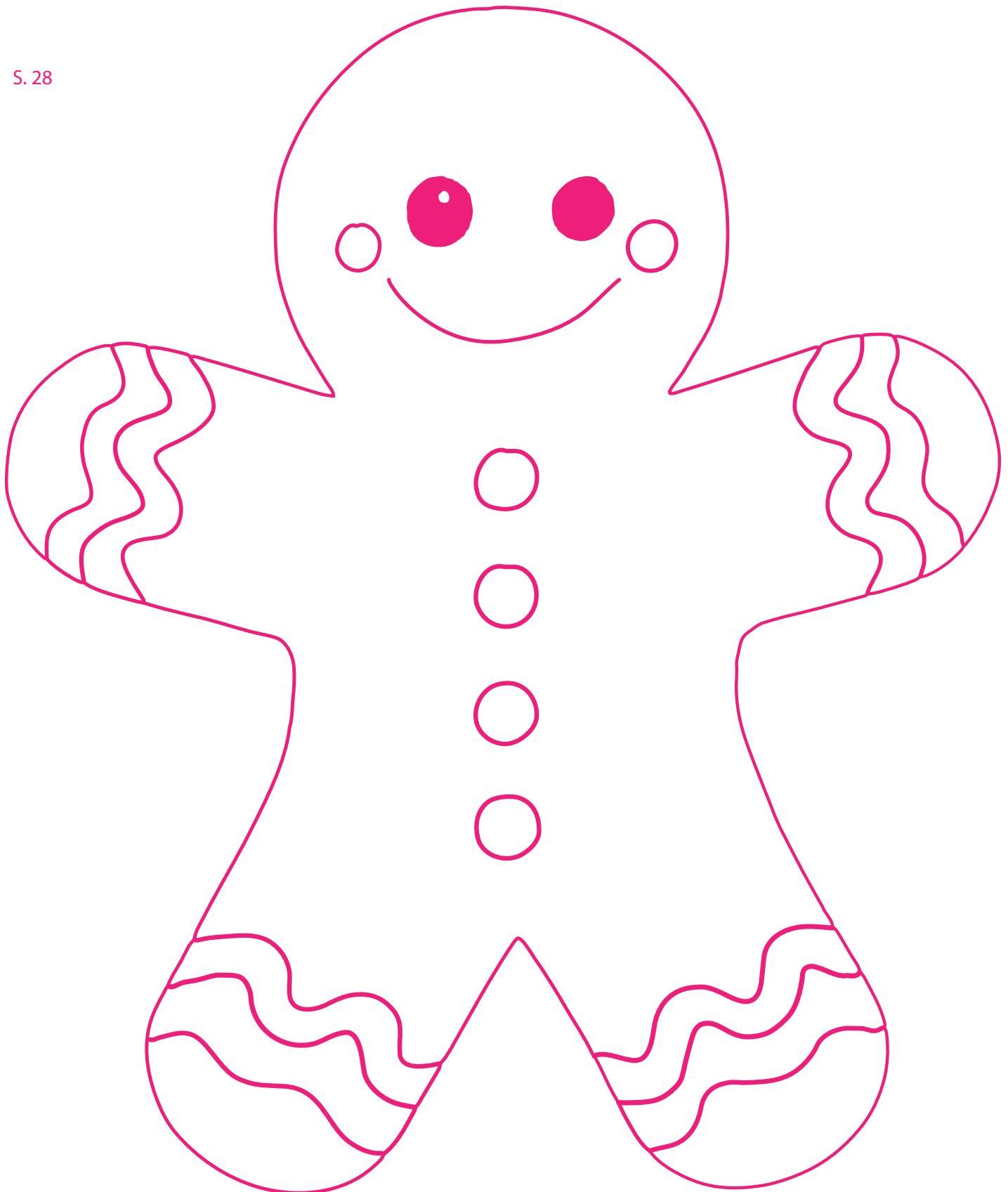

**HINWEISE ZUR BENUTZUNG DES  
VORLAGEBOGENS:**

- = Schnittlinie
- ..... = darunterliegende Schnittlinie
- - - - - = Faltlinie

S. 40

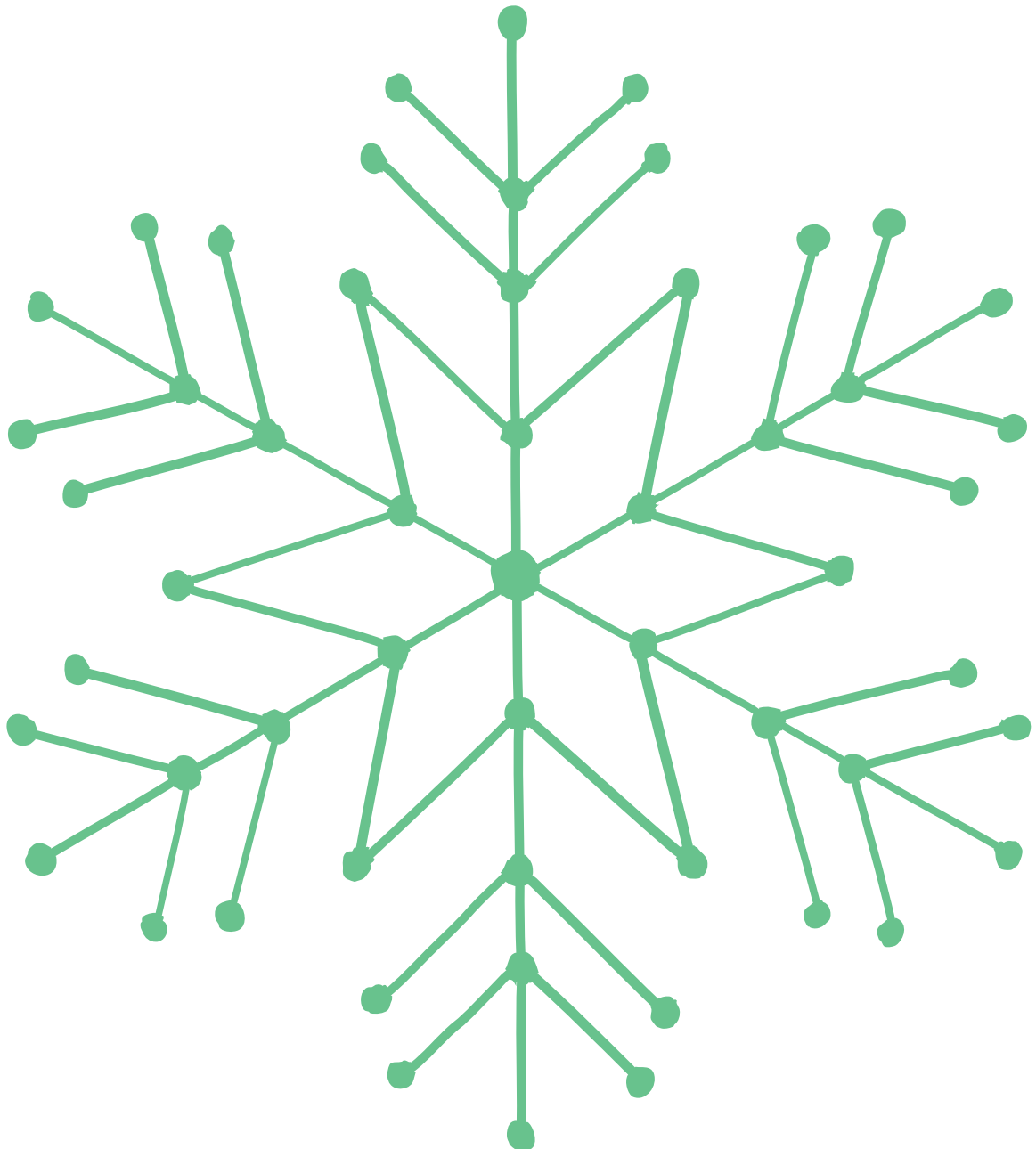

**HINWEISE ZUR BENUTZUNG DES  
VORLAGEBOGENS:**

- = Schnittlinie
- ..... = darunterliegende Schnittlinie
- - - - - = Faltlinie

S. 41

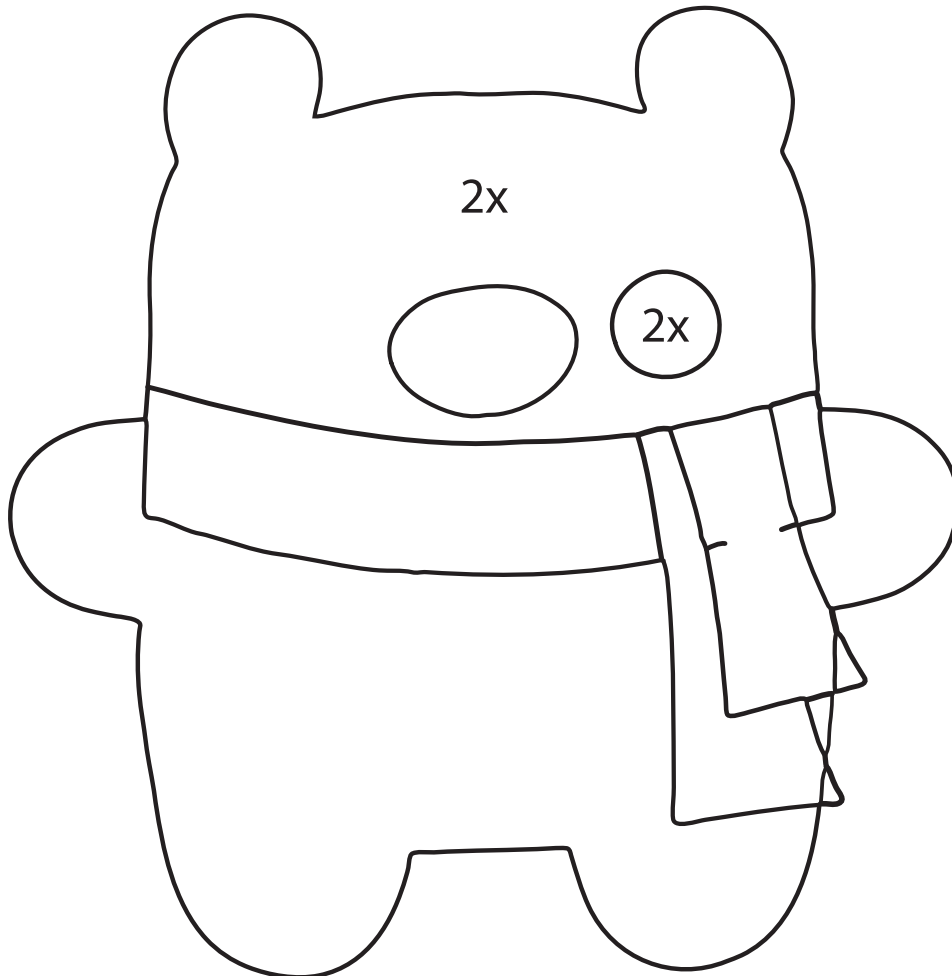



**HINWEISE ZUR BENUTZUNG DES  
VORLAGEBOGENS:**

- = Schnittlinie
- ..... = darunterliegende Schnittlinie
- - - - - = Faltlinie

S. 42

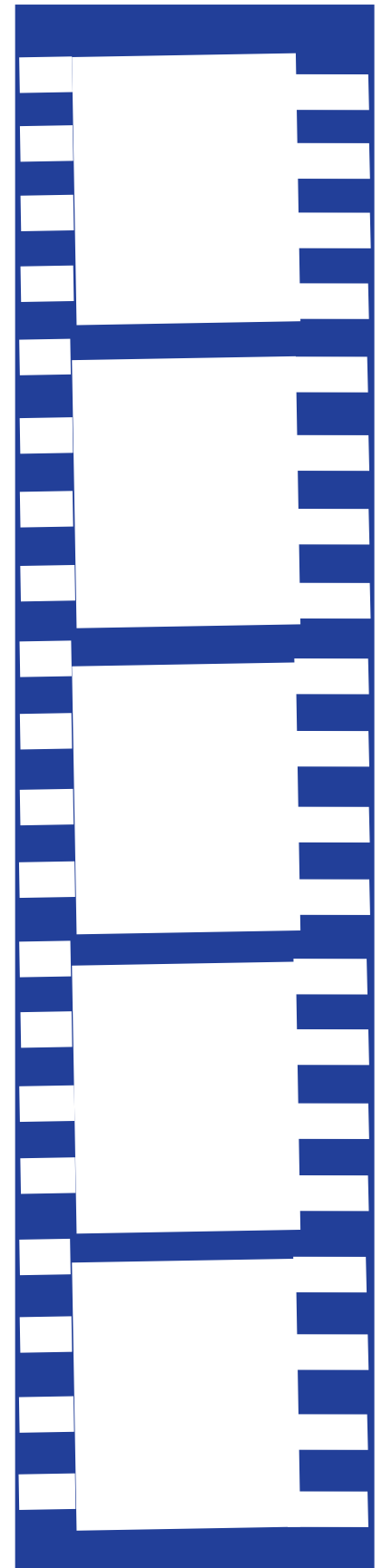
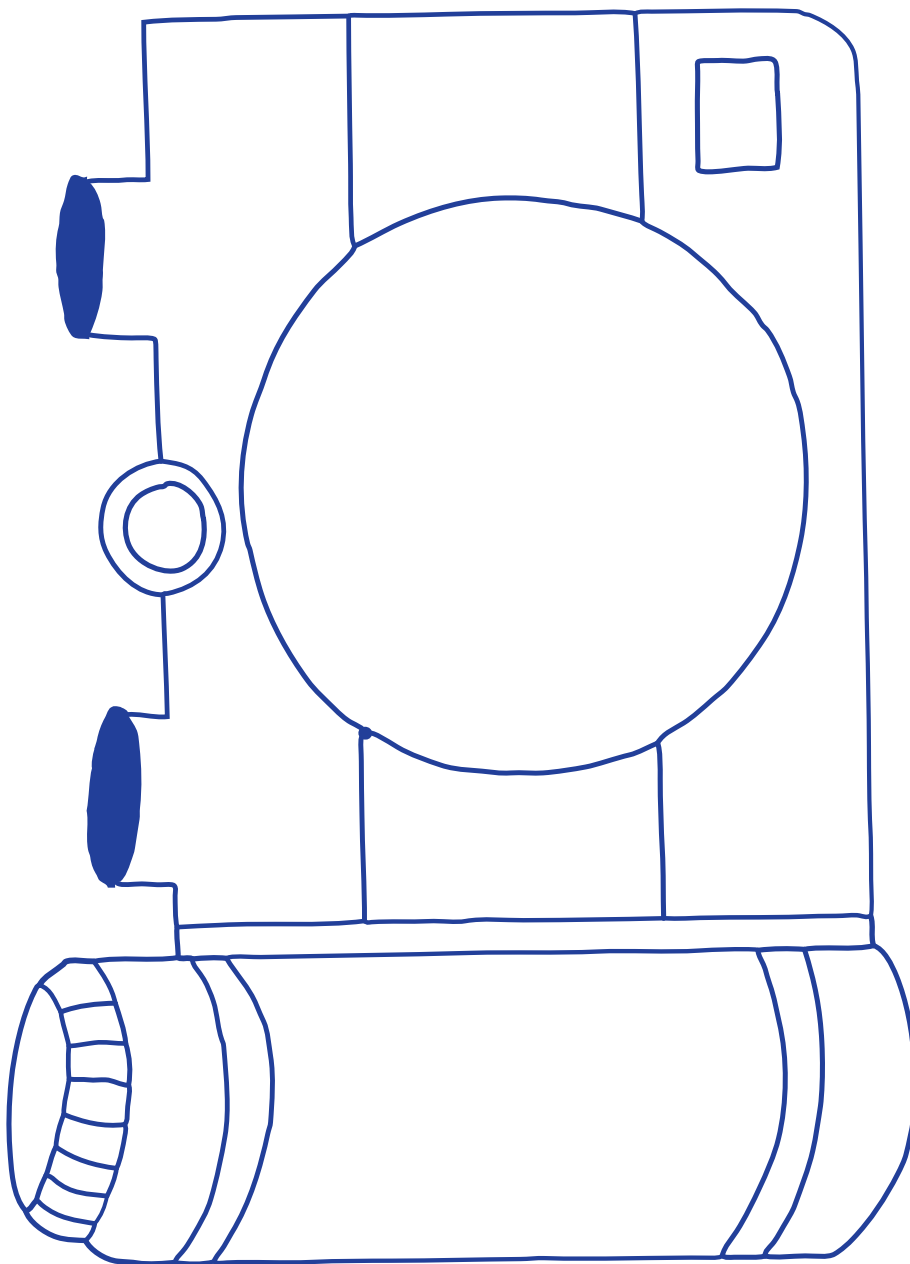

**HINWEISE ZUR BENUTZUNG DES VORLAGEBOGENS:**

- = Schnittlinie
- ..... = darunterliegende Schnittlinie
- - - - - = Faltlinie

S. 44

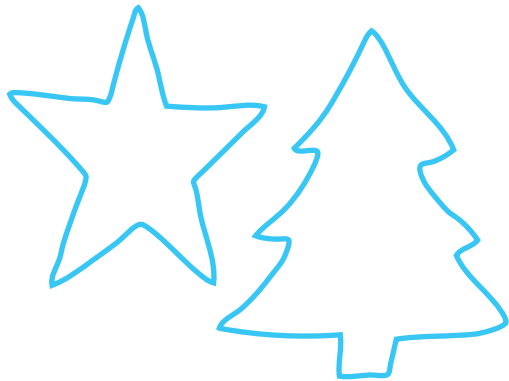

S. 46

